

Customer Part:

Description

- Standard 7 x 5mm crystal oscillator in a ceramic package with a seam sealed metal lid, hermetically sealed.
- Model CFPS-73
- Model Issue number 15

Frequency Parameters

- Frequency 64.0MHz
- Frequency Stability ±50.00ppm
- Operating Temperature Range 0.00 to 70.00°C
- Ageing ±5ppm per year

Electrical Parameters

- Supply Voltage 3.3V ±10%
- Current Draw 38.000mA
- Note: parameters are referenced to 15pF load

Output Details

- Output Compatibility CMOS
- Drive Capability 15pF std, 30pF max
- Rise and Fall Time 8.0ns max
- Duty Cycle 40/60
- Start up time: 10ms max.

Output Control

- Standby Operation:
 Logic '1' (>70% VS) to pad 1 enables oscillator output
 Logic '0' (<30% VS) to pad 1 disables oscillator output; the oscillator output goes to the high impedance state
 No connection to pad 1 enables oscillator output
 Standby Current: 10µA max

Environmental Parameters

- Shock: Half Sine shock pulse with peak acceleration 500g; Pulse duration: 0.3ms
- Vibration: MIL-STD-202 Method 204. 5g for 20 minutes, 12 cycles in each of the 3 orientations, 10 - 2000 Hz. As per Table 11 of AEC-Q200.
- Storage Temperature Range: -55 to 125°C

Manufacturing Details

- RoHS Terminations NiAu
- RoHS Reflow Temp 260°C 10s max

Compliance

- RoHS Status (2015/863/EU) Compliant
- REACH Status Compliant
- MSL Rating (JDEC-STD-033): Not Applicable

Packaging Details

- Tape & reel in accordance with EIA-481
 Quantities below the standard reel size to be supplied on cut tape.

Standard Pack Quantity: 1,000

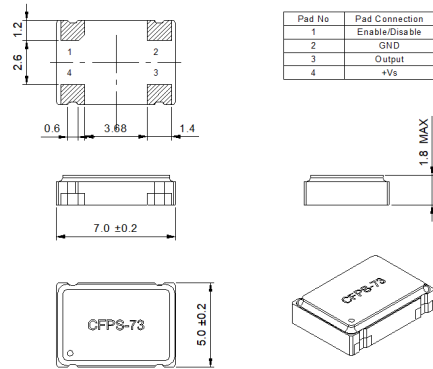
Outline (mm)

Note: Please note that due to the availability of ceramic bases in the marketplace, you may see slight cosmetic differences in the appearance of this item; however the electrical performance is unaffected.

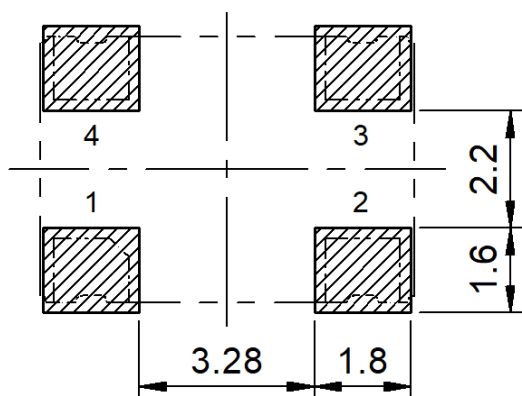
Recommended Solder Pad Layout

Sales Office Contact Details:

UK: +44 (0)1460 270200

 Email: info@iqdfrequencyproducts.com

 Web: www.iqdfrequencyproducts.com

Customer Part:

Test Circuit

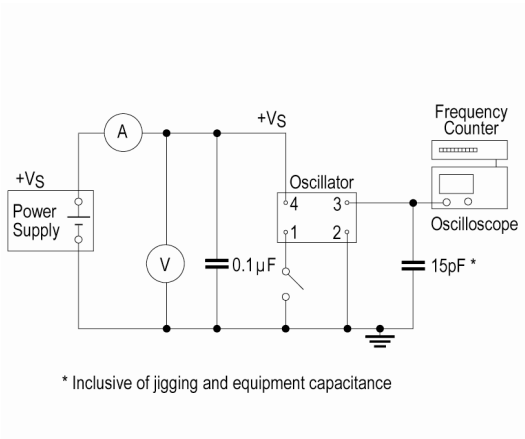

Waveform

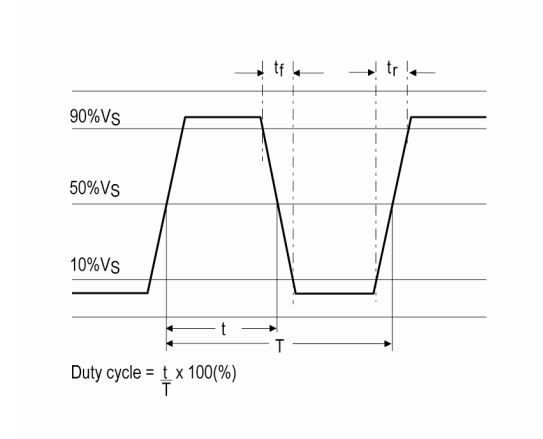

Sales Office Contact Details:

UK: +44 (0)1460 270200

Email: info@iqdfrequencyproducts.com

Web: www.iqdfrequencyproducts.com