

**Customer Part:**

**Description**

- 5 x 3.2mm crystal oscillator  
Ceramic package with a seam sealed metal lid, hermetically sealed
- Model CFPS-9
- Model Issue number 9
- Note: please be aware that devices supplied against this model may show slight cosmetic differences depending upon the frequency and specification, however all electrical details remain as per the model specification.

**Frequency Parameters**

- Frequency 20.0MHz
- Frequency Stability ±25.00ppm
- Operating Temperature Range -10.00 to 70.00°C
- Ageing ±5ppm max per year @ 25°C

**Electrical Parameters**

- Supply Voltage 3.3V ±10%
- Current Draw 38.000mA

**Output Details**

- Output Compatibility CMOS
- Drive Capability 15pF max
- Rise and Fall Time 10.0ns max
- Duty Cycle 40/60
- Start up time: 10ms max

**Output Control**

- Enable/Disable Operation:  
Logic '1' (>70% VS) to pad 1 enables oscillator output  
Logic '0' (<30% VS) to pad 1 disables oscillator output; when disabled the oscillator output goes to the high impedance state  
No connection to pad 1 enables oscillator output  
Standby Current: 10µA max

**Environmental Parameters**

- Storage Temperature Range: -55 to 125°C
- Shock: Half Sine shock pulse with peak acceleration 500g;  
Pulse duration: 0.3ms
- Vibration: MIL-STD-202 Method 204. 5g for 20 minutes, 12 cycles in each of the 3 orientations, 10 - 2000 Hz. As per Table 11 of AEC-Q200.

**Manufacturing Details**

- RoHS Terminations NiAu
- RoHS Reflow Temp 260°C 10s max

**Compliance**

- RoHS Status (2015/863/EU) Compliant
- REACH Status Compliant
- MSL Rating (JDEC-STD-033): Not Applicable

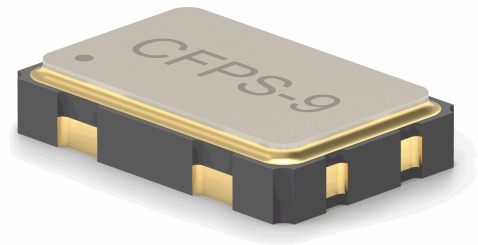
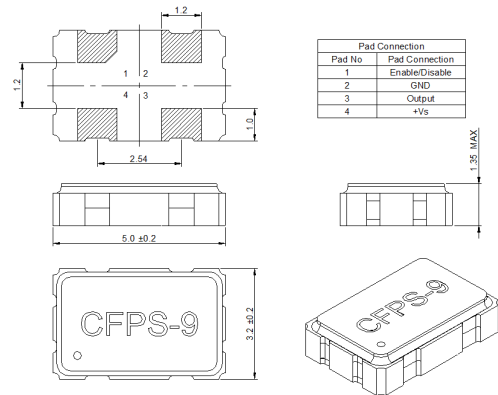
**Outline (mm)**

NOTE: The shape of pad 1 may differ from the drawing. The device may or may not have side pads. This causes no change on electrical performance of the device.

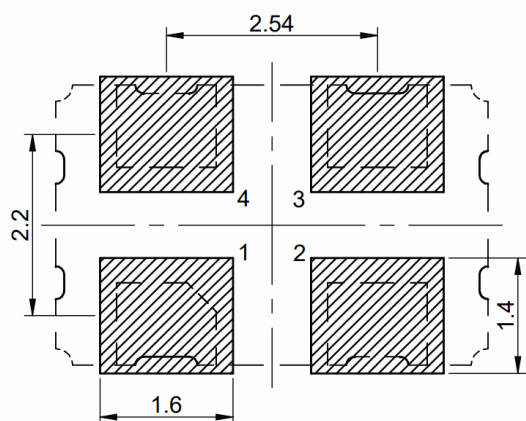
**Recommended Solder Pad Layout**

**Sales Office Contact Details:**

UK: +44 (0)1460 270200

USA: +1 760 668 8935

 Email: [info@iqdfrequencyproducts.com](mailto:info@iqdfrequencyproducts.com)

 Web: [www.iqdfrequencyproducts.com](http://www.iqdfrequencyproducts.com)

### Customer Part:

#### Packaging Details

- Tape & reel in accordance with EIA-481  
Quantities below the standard reel size to be supplied on cut tape.  
Standard Quantity: 1,000 Pieces

### Test Circuit

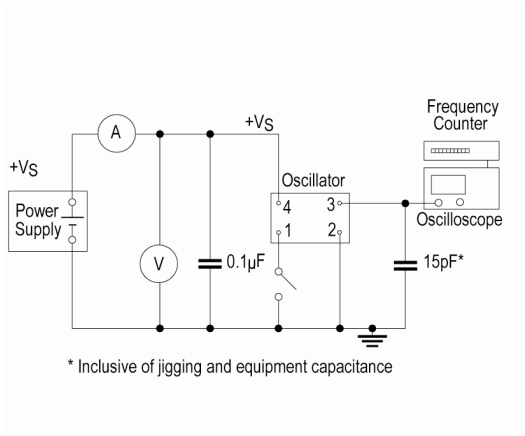

### Waveform

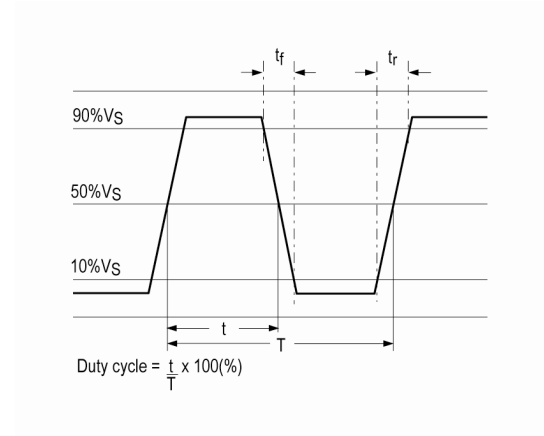

### Sales Office Contact Details:

UK: +44 (0)1460 270200

USA: +1 760 668 8935

Email: [info@iqdfrequencyproducts.com](mailto:info@iqdfrequencyproducts.com)

Web: [www.iqdfrequencyproducts.com](http://www.iqdfrequencyproducts.com)