

Description

- LVPECL output oscillator using a high frequency fundamental crystal to give very low jitter, hermetically sealed in a ceramic package with a seam sealed metal lid
- Standby on pad 1, pad 2 N/C
- Model CFPS-34
- Model Issue number 5

Frequency Parameters

- Frequency 125.0MHz
- Frequency Stability $\pm 100.00\text{ppm}$
- Operating Temperature Range -10.00 to 70.00°C
- Ageing $\pm 2\text{ppm}$ max per year

Electrical Parameters

- Supply Voltage $3.3\text{V} \pm 5\%$
- Current Draw 60.00mA

Output Details

- Output Compatibility LVPECL
- Drive Capability 50Ω terminated to $V_s - 2.0\text{V}$
- Rise and Fall Time 1.0ns max
- Duty Cycle $40/60\%$

Output Control

- Logic '1' ($>70\%$ V_s) to pad 1 enables oscillator output
Logic '0' ($<30\%$ V_s) to pad 1 disables oscillator output; the oscillator output goes to the high impedance state
No connection to pad 1 enables oscillator output
- Stand-by Current: $30\mu\text{A}$ max
- Start Up Time: 10ms max

Output Levels

- '0' Level V_{oL} : $+1.7\text{V}$ max
- '1' Level V_{oH} : $+2.2\text{V}$ min

Noise Parameters

- Phase Jitter (12kHz to 20MHz): 1ps rms max

Environmental Parameters

- Storage Temperature Range: -55 to 125°C
- Shock: MIL-STD-202F, Method 213B: 1000G , 0.5ms , $1/2$ sine wave
- Vibration: MIL-STD-202F, Method 204D, Test Condition D: 20G (10Hz - 2000Hz), 4hrs in 3 mutually perpendicular planes (total 12hrs)

Compliance

- RoHS Status (2011/65/EU) Compliant
- REACH Status Compliant
- MSL Rating (JDEC-STD-033): Not Applicable

Packaging Details

- Pack Style: Bulk Loose in bulk pack
Pack Size: 100
- Alternative packing option available

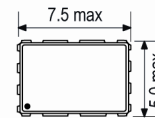
Outline (mm)

- Pad Connections
- Standby Operation
 - N/C
 - GND
 - Output 1
 - Output 2
 - $+V_s$

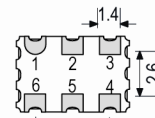

Underside View

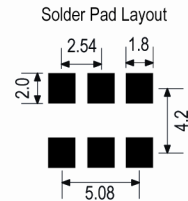
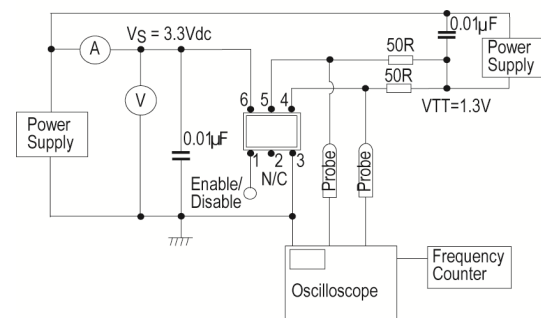

Test Circuit

Sales Office Contact Details:

UK: +44 (0)1460 270200
Germany: 0800 1808 443

France: 0800 901 383
USA: +1.760.318.2824

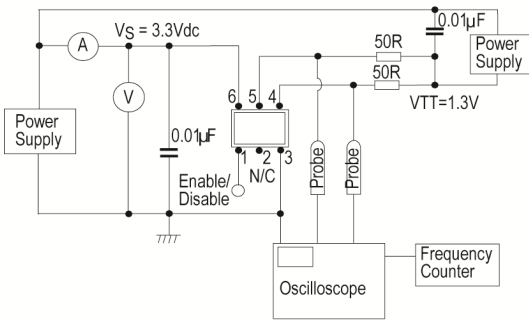
Email: info@iqdfrequencyproducts.com
Web: www.iqdfrequencyproducts.com

Test Circuit



Wave Form

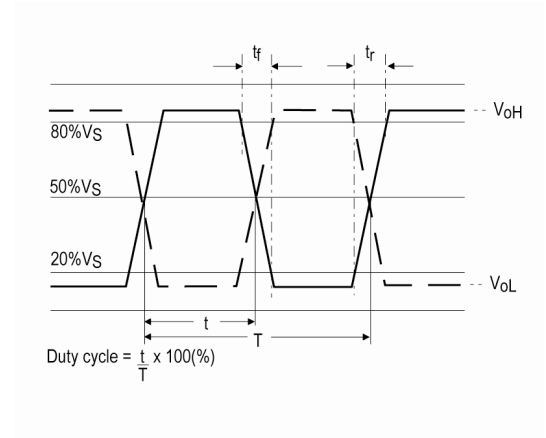

Sales Office Contact Details:

UK: +44 (0)1460 270200
 Germany: 0800 1808 443

France: 0800 901 383
 USA: +1.760.318.2824

Email: info@iqdfrequencyproducts.com
 Web: www.iqdfrequencyproducts.com