

Description

- LVPECL output crystal oscillator using a high frequency fundamental crystal to give very low jitter. Hermetically sealed ceramic package with a seam sealed metal lid.
- Model IQXO-621
- Model Issue number 3

Frequency Parameters

- Frequency 155.520MHz
- Frequency Stability $\pm 50.00\text{ppm}$
- Operating Temperature Range -40.00 to 85.00°C
- Ageing $\pm 3\text{ppm}$ max per year @ 25°C

Electrical Parameters

- Supply Voltage $2.5\text{V} \pm 5\%$
- Current Draw 70.000mA

Output Details

- Output Compatibility LVPECL
- Drive Capability 50Ω terminated to $V_S - 2.0\text{V}$
- Rise and Fall Time 0.5ns max
- Duty Cycle $45/55\%$
- Output Voltage Levels:
Output Low (VoL): 1.095V max
Output High (VoH): 1.475V min

Output Control

- Enable/Disable:
Logic '1' ($70\% V_S$ min) to pad 1 enables oscillator output.
Logic '0' ($30\% V_S$ max) to pad 1 disables oscillator output; the oscillator output goes to the high impedance state.
No connection to pad 1 enables oscillator output.
Standby Current: $10\mu\text{A}$ max

Noise Parameters

- Phase Jitter (12kHz to 20MHz): 1ps rms max

Environmental Parameters

- Storage Temperature Range: -55 to 125°C
- Shock: MIL-STD-202, Method 213, Condition E: 1000G, 0.5ms , half sine wave.
- Vibration: MIL-STD-883, Method 2007, Condition A: 20G

Compliance

- RoHS Status (2011/65/EU) Compliant
- REACH Status Compliant
- MSL Rating (JEDEC-STD-033): Not Applicable

Packaging Details

- Pack Style: Reel Tape & reel in accordance with EIA-481-D
Pack Size: 1,000
- *Alternative packing option available*

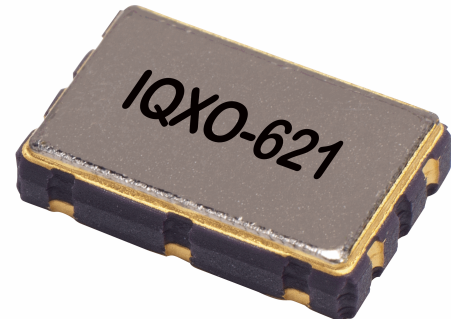
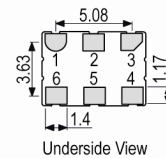
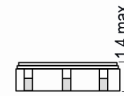
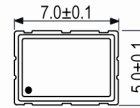
Outline (mm)

Pad Connections

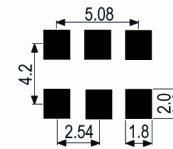
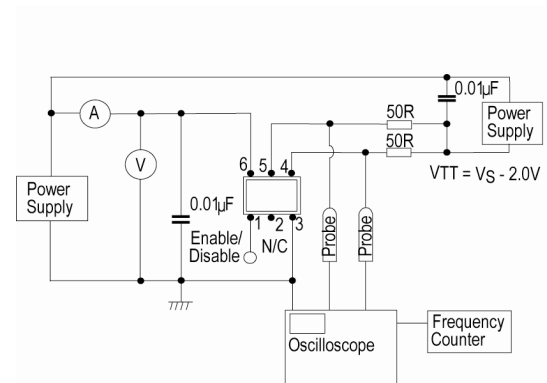
1. Enable/Disable
2. N/C
3. GND
4. Output +
5. Output -
6. +Vs

Solder Pad Layout

Test Circuit

Sales Office Contact Details:

UK: +44 (0)1460 270200
Germany: 0800 1808 443

France: 0800 901 383
USA: +1.760.318.2824

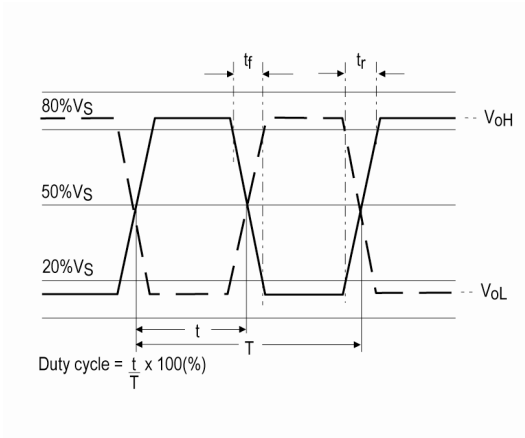
Email: info@iqdfrequencyproducts.com
Web: www.iqdfrequencyproducts.com

Wave Form



Sales Office Contact Details:

UK: +44 (0)1460 270200
Germany: 0800 1808 443

France: 0800 901 383
USA: +1.760.318.2824

Email: info@iqdfrequencyproducts.com
Web: www.iqdfrequencyproducts.com