

## Customer Part:



### Description

- LVPECL output crystal oscillator using a high frequency fundamental crystal to give very low jitter. Hermetically sealed ceramic package with a seam sealed metal lid.
- Model IQXO-621
- Model Issue number 3

### Frequency Parameters

- Frequency 156.250MHz
- Frequency Stability  $\pm 50.00\text{ppm}$
- Operating Temperature Range  $-40.00$  to  $85.00^\circ\text{C}$
- Ageing  $\pm 3\text{ppm}$  max per year @  $25^\circ\text{C}$

### Electrical Parameters

- Supply Voltage  $2.5\text{V} \pm 5\%$
- Current Draw  $70.000\text{mA}$

### Output Details

- Output Compatibility LVPECL
- Drive Capability  $50\Omega$  terminated to  $V_s - 2.0\text{V}$
- Rise and Fall Time  $0.5\text{ns}$  max
- Duty Cycle  $45/55\%$
- Output Voltage Levels:  
Output Low (VoL):  $1.095\text{V}$  max  
Output High (VoH):  $1.475\text{V}$  min

### Output Control

- Enable/Disable:  
Logic '1' ( $70\% V_s$  min) to pad 1 enables oscillator output.  
Logic '0' ( $30\% V_s$  max) to pad 1 disables oscillator output; the oscillator output goes to the high impedance state.  
No connection to pad 1 enables oscillator output.  
Standby Current:  $10\mu\text{A}$  max

### Noise Parameters

- Phase Jitter (12kHz to 20MHz):  $1\text{ps}$  rms max

### Environmental Parameters

- Storage Temperature Range:  $-55$  to  $125^\circ\text{C}$
- Shock: MIL-STD-202, Method 213, Condition E: 1000G,  $0.5\text{ms}$ , half sine wave.
- Vibration: MIL-STD-883, Method 2007, Condition A: 20G

### Compliance

- RoHS Status (2015/863/EU) Compliant
- REACH Status Compliant
- MSL Rating (JDEC-STD-033): Not Applicable

### Packaging Details

- Pack Style: Bulk Loose in bulk pack  
Pack Size: 100
- *Alternative packing option available*

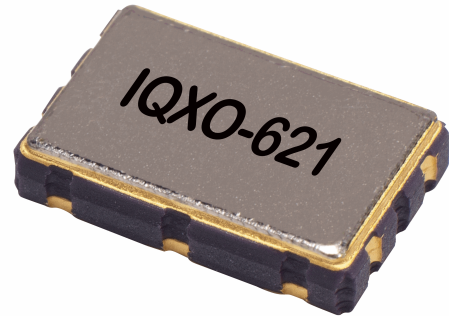

### Outline (mm)

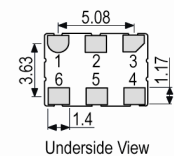
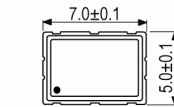

#### Pad Connections

1. Enable/Disable
2. N/C
3. GND
4. Output +
5. Output -
6. +Vs

#### Solder Pad Layout

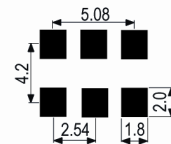

### Test Circuit

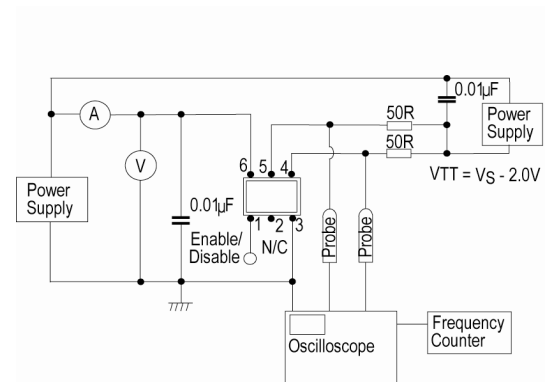

### Sales Office Contact Details:

UK: +44 (0)1460 270200

Germany: 0800 1808 443

France: 0800 901 383

USA: +1.760.318.2824

Email: [info@iqdfrequencyproducts.com](mailto:info@iqdfrequencyproducts.com)

Web: [www.iqdfrequencyproducts.com](http://www.iqdfrequencyproducts.com)

**Customer Part:**

**Wave Form**

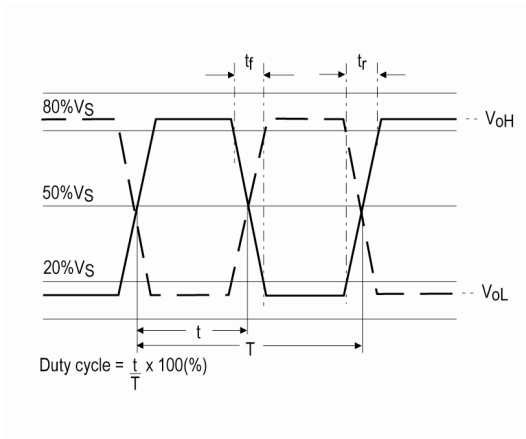

**Sales Office Contact Details:**

UK: +44 (0)1460 270200  
Germany: 0800 1808 443

France: 0800 901 383  
USA: +1.760.318.2824

Email: [info@iqdfrequencyproducts.com](mailto:info@iqdfrequencyproducts.com)  
Web: [www.iqdfrequencyproducts.com](http://www.iqdfrequencyproducts.com)